

Fault Analysis of Power System using MATLAB

Akriti Sinha¹, Shreya Anand², Prof. Vishal Mehtre³

Department of Electrical Engineering, Bharati Vidyapeeth (DU) College of Engineering, Pune, India

ABSTRACT: This paper analyses the fault of a power system using MATLAB/Simulink. Several faults including single-line-to-ground, line-to-line, double-line-to-ground, and three phase faults have been analyzed and their effects on the operation the power system are studied. This simulation was carried out by designing the model using a test system and applying several faults at different positions and for different time duration. Various parameters like fault current, bus voltage, and system stability are analyzed during the fault and after fault conditions.

It was observed that both the type of fault and fault position have a great influence on the magnitude of fault current and system voltage. It is found that MATLAB/Simulink is a good tool for simulating and analyzing fault conditions of power systems. This paper is very helpful in understanding how a power system behaves during abnormal conditions and will help in designing protection devices such as relays and circuit breakers to ensure system stability and reliability.

KEYWORDS: Power System, Fault Detection, Electrical Fault, MATLAB/Simulink, Three Phase Fault, System Stability.

I. INTRODUCTION

In modern power systems, the occurrence of faults is unavoidable due to various reasons such as lighting, insulating failure, equipment malfunction, and external disturbances. Faults can disrupt the normal functioning of a power system and, if not identified and cleared in time, they may cause serious damage. Faults in power system can occur due to lightning insulation failure or equipment malfunction and can stop the system stability [1],[2]. That is why fault analysis is very important for maintaining the system's reliability, stability, and overall safety [3],[4].

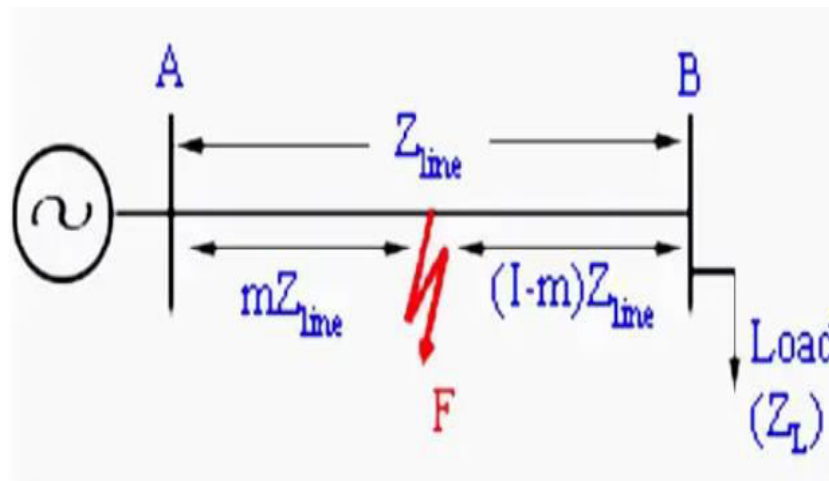

Figure 1: TRANSMISSION LINE FAULT

In power systems, faults are mainly divided into two types: symmetrical and unsymmetrical faults [5],[6]. Symmetrical faults are also called as balanced fault and are the very serious. While unsymmetrical faults are unbalanced faults and occur more frequently [6],[7].

While studying faults, it is important to understand their effects. When a fault happens, the current increases suddenly and the voltage drops. This can damage important equipment like generators, transformers, and transmission lines. If the fault is not cleared quickly, it can reduce the life of the equipment or even cause complete system failure. To prevent such problems, protective devices like relays and circuit breakers are used [4],[10]. These devices quickly detect the fault and isolate the faulty part quickly of the system. This helps in protecting the rest of the system and ensures smooth operation. Fault analysis is also useful for calculating short circuit currents, which helps in designing system components with proper ratings. It also helps engineers understand system behavior in both normal and faulty condition.

During a fault, current increases rapidly while voltage drops significantly, affecting the system components [8]. And if not cleared quickly, faults can damage equipment and reduce system life [3],[9].

II. TYPES OF FAULTS

Faults in a power system are abnormal conditions that stop the normal flow of current. Faults are generally classified into parts symmetrical and unsymmetrical based on the system balance. These include:

1. Single-line-to-ground (L-G) fault:

- This happens when one phase touches the ground.
- It is the most common type of fault.

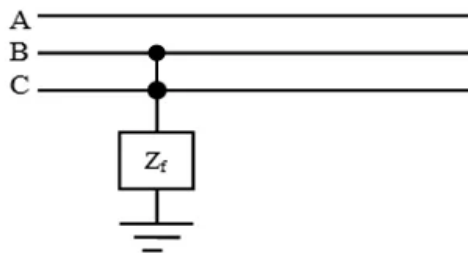

Figure 2: SINGLE LINE-TO-GROUND

2. Line-to-line (L-L) fault:

- In this, two phases come in contact with each other, causing high current between them.
- It is less common than line to ground fault.



Figure 3: LINE-TO-LINE FAULT

3. Double line-to-ground (L-L-G) fault:

- This involves two phases and the ground, so it is more severe than line to ground and line to line faults.
- It has high fault current.

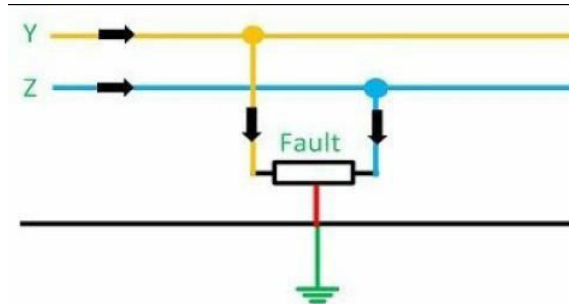

Figure 4:DOUBLE-LINE-TO-GROUND

4. Three phase (L-L-L) fault:

- This is symmetrical fault where all three phases are involved.
- It produces very high current and it is the most severe fault.

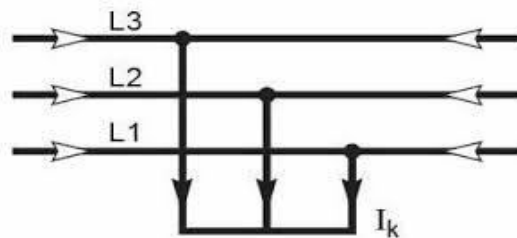

Figure 5: THREE PHASE FAULT

II. LITERATURE REVIEW

Fault analysis in power system has been studied by many researchers to make systems safer and more reliable. Different methods have been developed overtime to understand various types of faults and how they affect the system performance. One commonly used traditional methods is the symmetrical components technique which helps them in analyzing unbalanced faults.

With the development of modern tools, software-based analysis has become more important. Many studies have been done using modeling and simulation of system faults with MATLAB/Simulink as it is easy to use and very accurate. It allows us to analyze various types of faults and observe how the current and voltage varies during different types of faults. Recent studies have begun to use intelligent techniques for fault detection. These methods can quickly and accurately detect faults, and can be used to improve the safety protection of the power system.

In summary, the past studies show that simulation is a good and effective method to study the behavior of the system and to improve the protection system.

MATLAB SIMULATION

MATLAB is a software used for programming, calculations and data analysis in engineering. It also helps in showing results using graphs, waveforms etc. Simulink is a part of MATLAB that is used to create and simulate system using block diagrams. In MATLAB we can create Electrical circuit models. MATLAB/Simulink provides a flexible environment for modeling and analyzing power system faults [1].

In power system, MATLAB/Simulink is used to build models apply different conditions, and study how the system behaves. It allows easy use of components like source transmission line load fold blocks generator transformer etc. Because it is easy to use, flexible and gives accurate results. Simulation tool helps in understanding system behavior under fault conditions .

COMPONENTS USED IN THE MATLAB MODEL:

- Three-Phase Source
- Three-Phase Transformer (Two Winding)
- Three-Phase V-I Measurement
- Three-Phase Parallel RLC Load
- Three-Phase Fault
- Power Gui
- Scope Block

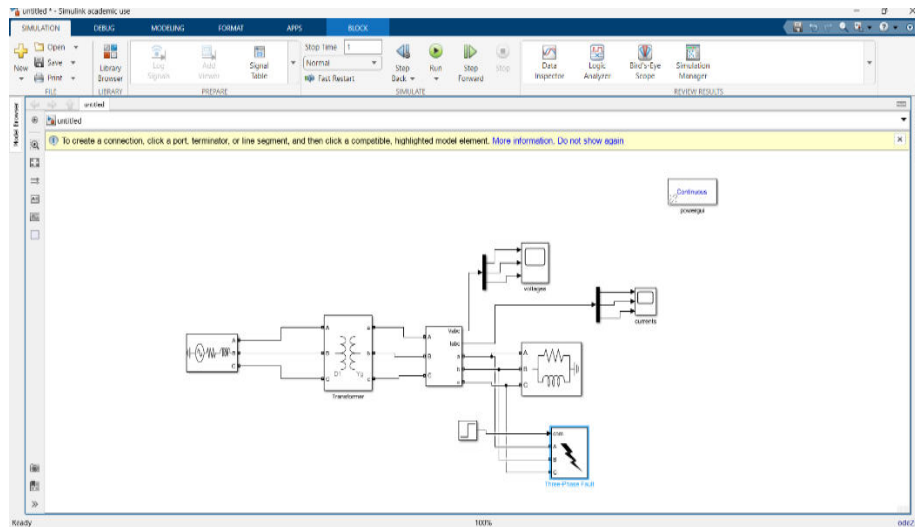

Figure 6 :MODEL OF POWER SYSTEM

III. METHODOLOGY

In this project, fault analysis is done using MATLAB. A simulation model is created to represent a basic power system, which includes a power source transmission line and load. Simulink provides different electrical components and tools that help in building and analyzing the system under different fault conditions.

First, a 3-phase power system model is built using components like a 3-phase source, transmission line, and load. Measurement blocks are also added to check important values like voltage, current, frequency, and power at different points. The system is forced to run under normal conditions to see how it works normally.

After that, different types of faults are added to the system using the fault block available in Simulink. The faults included in this study are single-line-to-ground (L-G), line-to-line (L-L), double-line-to-ground (L-L-G), and three-phase (L-L-L) faults. These faults are applied at specific locations and for a certain time to see their effect on the system. Overall, this method gives a clear and simple way to study faults and check how the power system performs under abnormal conditions.

IV. RESULTS AND DISCUSSIONS

The simulation of the power system under different fault conditions is carried out using MATLAB/Simulink, and the results are analyzed based on voltage and current waveforms obtained from the system.

NORMAL CONDITION

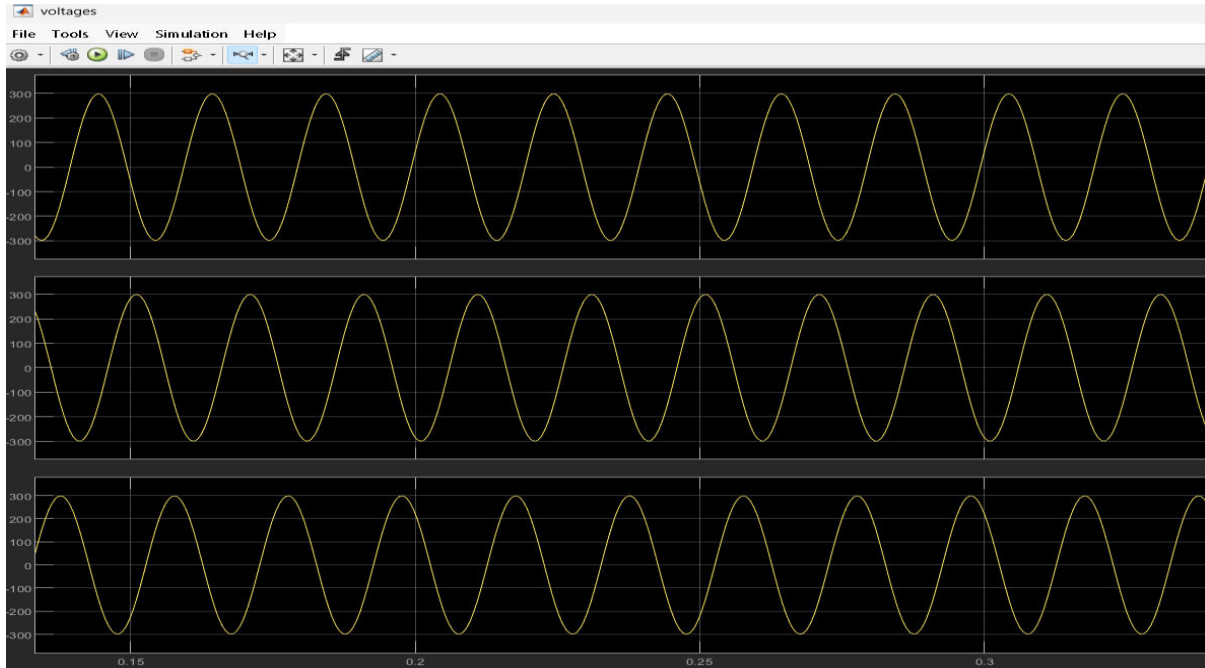

Figure 7: VOLTAGE WAVEFORM (N-O)

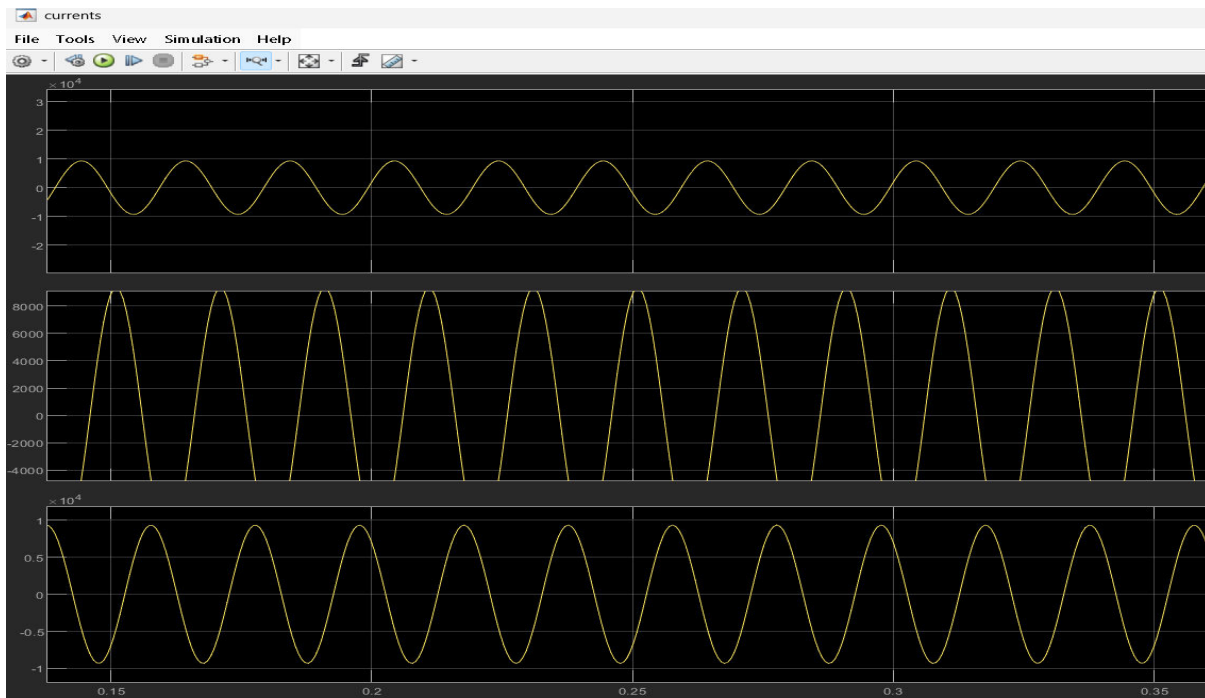

Figure 8: CURRENT WAVEFORM (N-O)

SINGLE LINE-TO-GROUND

In this condition a sharp increase in current is observed in the affected phase, along with a significant voltage drop in that phase, while other phases are less affected.

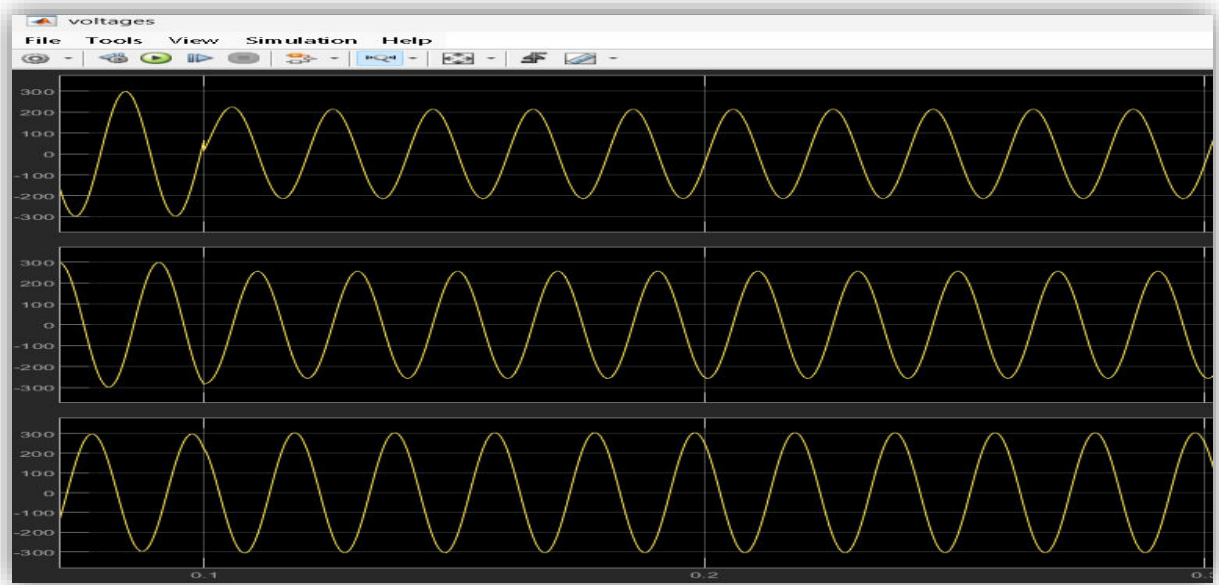

Figure 9: VOLTAGE WAVEFORM (L-G)

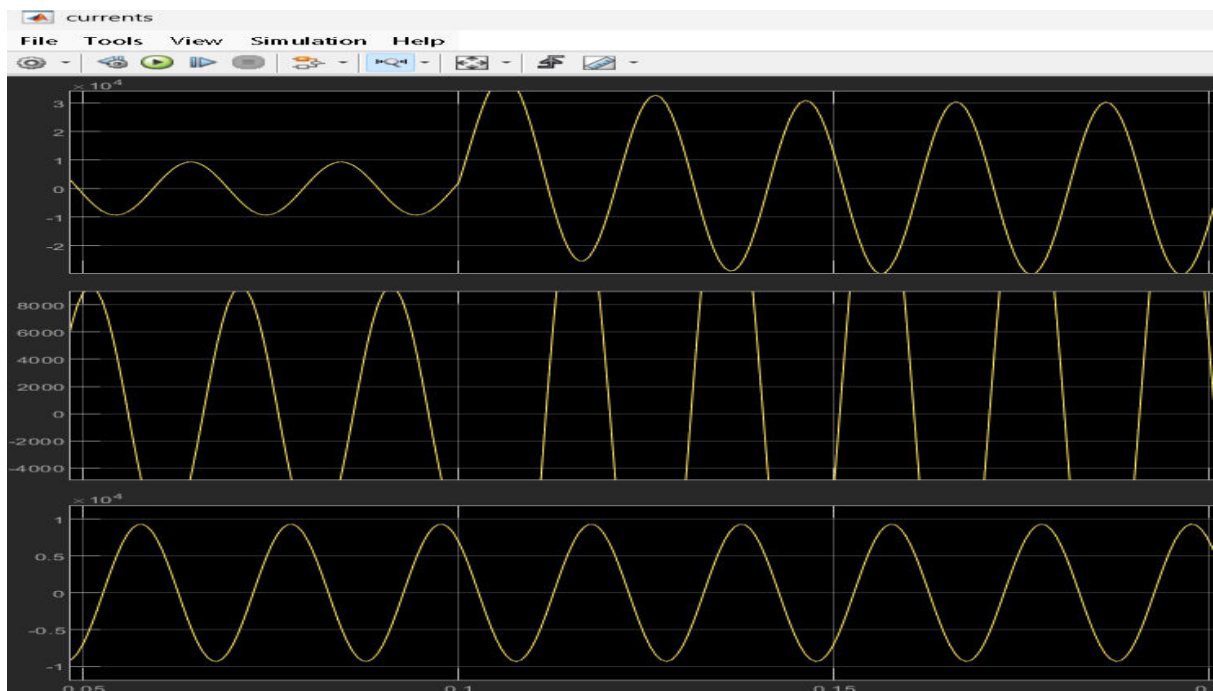

Figure 10: CURRENT WAVEFORM (L-G)

LINE TO LINE(L-L) FAULT

In this condition, Two phases experience high fault current and reduced voltage, whereas the 3rd phase remain completely stable.

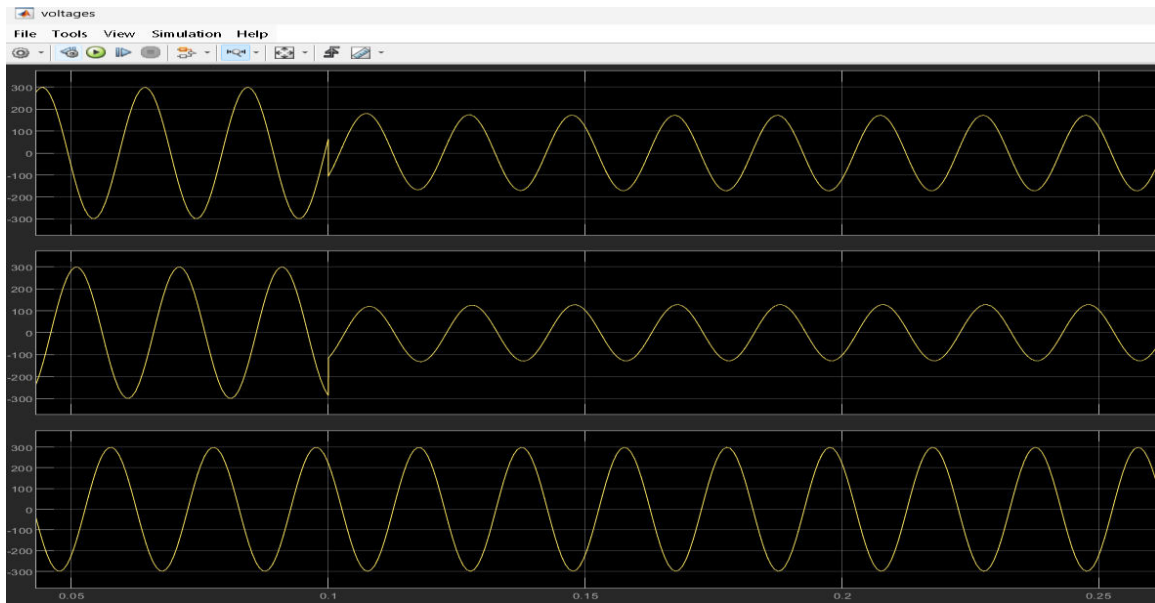

Figure 11: VOLTAGE WAVEFORM(L-L)

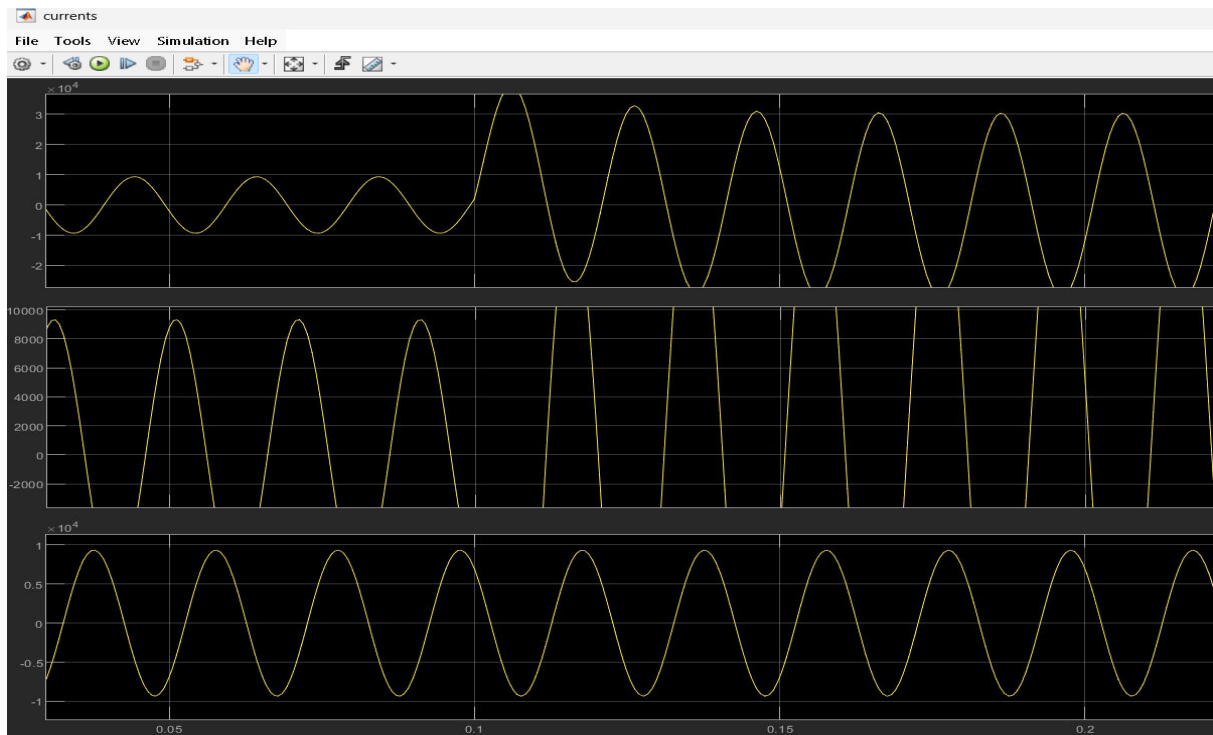

Figure 12: CURRENT WAVEFORM (L-L)

Double line to ground (L-L-G) fault

In this condition, both the high fault current and major voltage drops are observed in two phases along with ground, making it more dangerous than L-G and L-L faults.

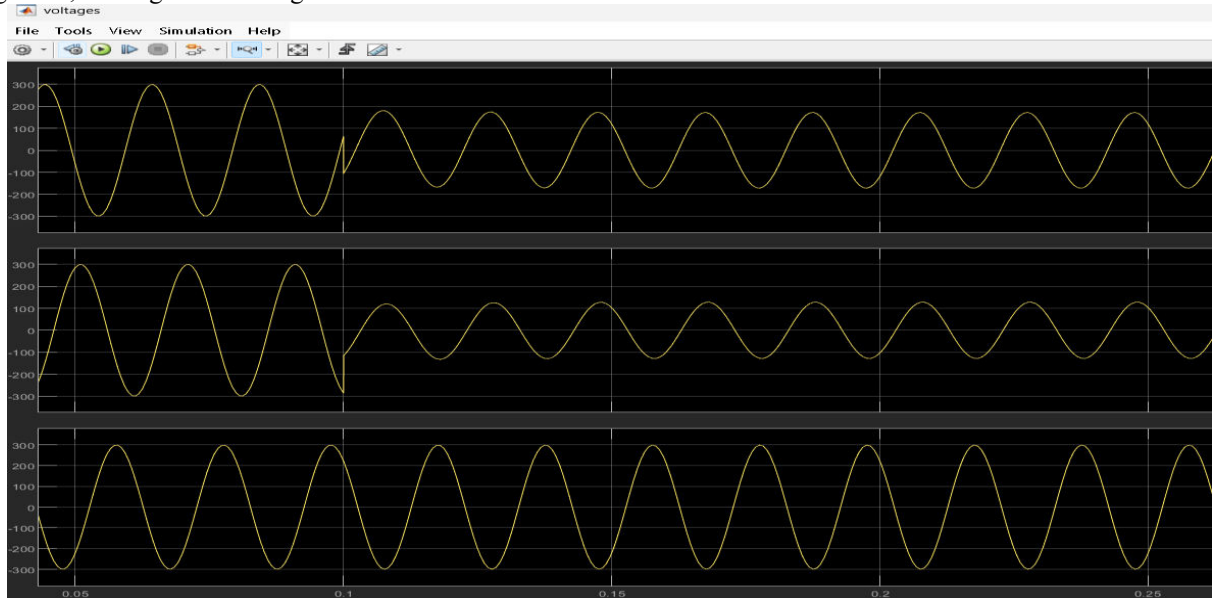

Figure 13: VOLTAGE WAVEFORM (L-L-G)

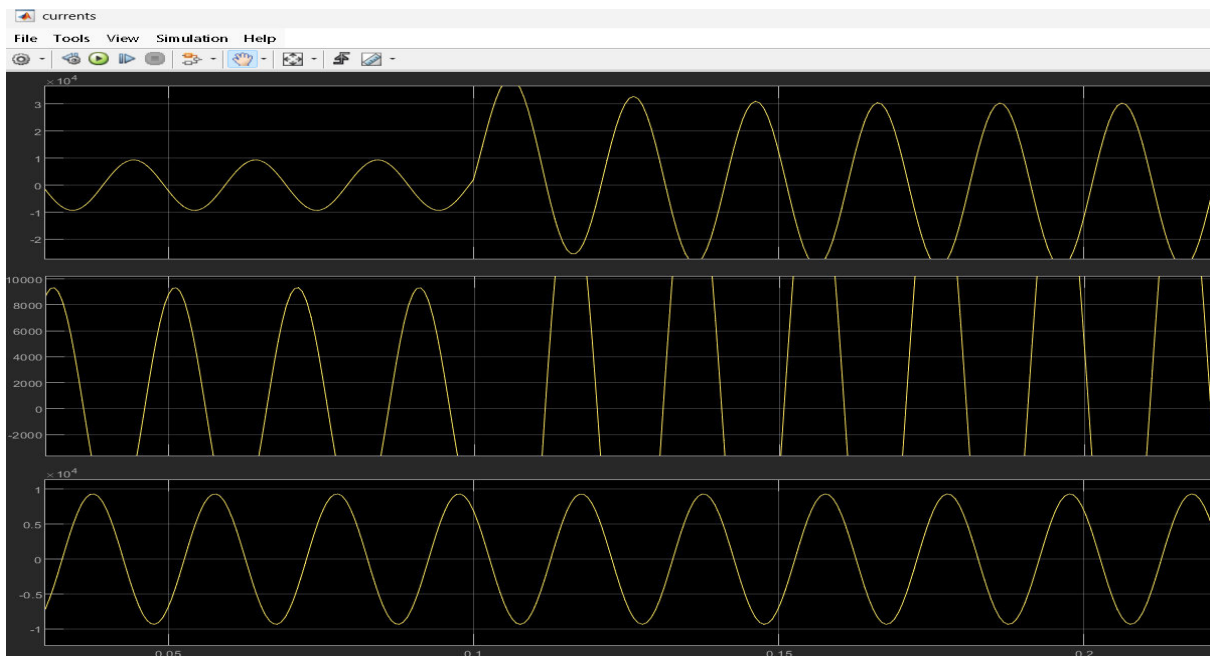

Figure 14: CURRENT WAVEFORM (L-L-G)

THREE PHASE(L-L-L) FAULT

In this condition fault results in the highest fault current and complete voltage collapse at the fault location, making it the most dangerous fault condition.

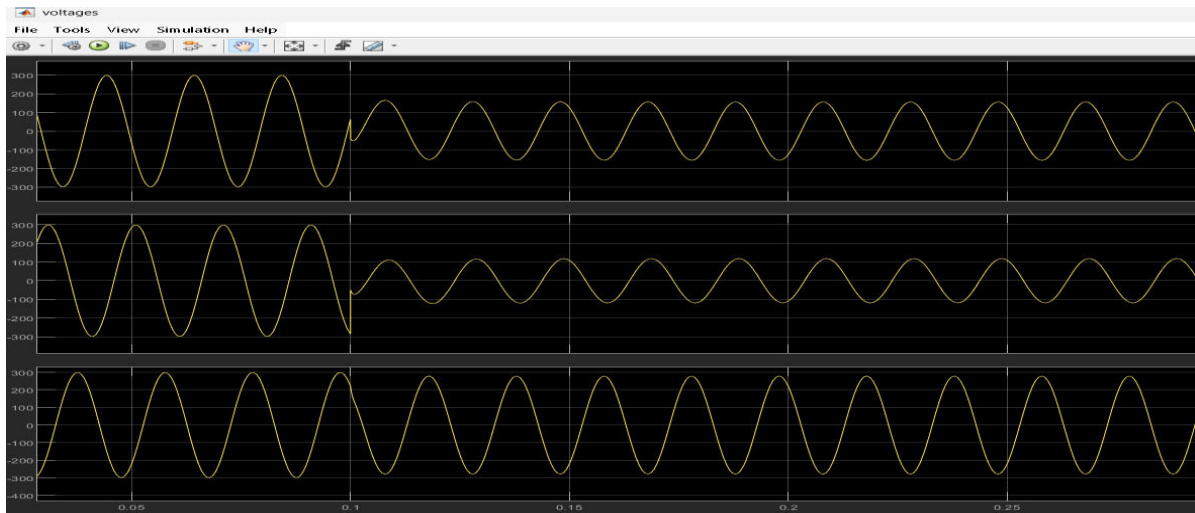

Figure 15: VOLTAGE WAVEFORM (L-L-L)

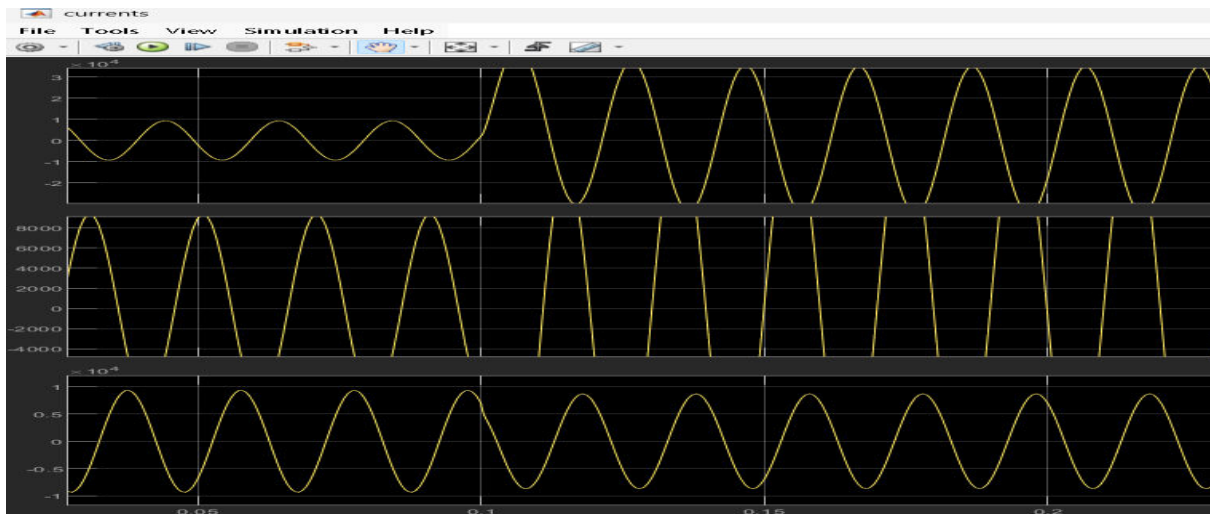

Figure 16: CURRENT WAVEFORM (L-L-L)

V. CONCLUSION

This project has fault analysis of a power system using MATLAB/Simulink. Here, Various faults such as single line-to-ground, line-to-line, double line-to-ground and three-phase faults are considered. The results indicates that these faults affect the system parameters such as voltage and current.

Among all the faults, the three-phase fault is found to be the most severe Because it produces the highest fault current and causes complete voltage drop. On the other hand, the single line- to-ground fault is the most common but less dangerous.

Using MATLAB/Simulink proved to be Very helpful for the modeling and analyzing False because it is flexible and easy to use. The waveforms obtained from the simulation Make it easier to understand how the system behaves during fault conditions.

This project demonstrates that it is necessary to study fault to maintain the reliability of the power system. This can also be used in the future to develop more efficient methods of fault detection and control.

REFERENCES

- [1] A. S. Hussein, "Power quality analysis based on simulation and MATLAB/Simulink," Indonesian Journal of Electrical Engineering and Computer Science, vol. 16, no. 3, pp. 1144–1153, 2019.
- [2] S. V. Rajguru, P. M. Patil, and S. R. Surve, "A review paper on MATLAB simulation for fault analysis of electrical circuit," International Journal of Advance Research and Innovative Ideas in Education (IJARIIE), vol. 5, no. 1, pp. 234–238, 2019.
- [3] A. Khan, M. Tariq, and S. U. Khan, "An accurate fault location algorithm for meshed power networks utilizing hybrid sparse voltage and current measurements," IEEE Access, vol. 8, pp. 12345–12356, 2020.
- [4] M. Sarwar, A. Haider, and S. Ahmad, "High impedance fault detection and isolation in power distribution networks using support vector machine," IEEE Access, vol. 7, pp. 123456–123465, 2019.
- [5] Y. Shanhan, "Ground fault analysis based on MATLAB-GUI," Journal of Electrical Engineering and Energy Management, vol. 6, no. 2, pp. 45–52, 2023.
- [6] S. Alam, M. Rahman, and N. Hossain, "Load flow analysis and fault detection of IEEE 9 bus system using wavelet transform in MATLAB-Simulink," International Journal of Electrical Power & Energy Systems, vol. 145, pp. 108–115, 2023.
- [7] Y. Ajra, M. Elharoussi, and B. Boukhriss, "A literature review of fault detection and diagnostic methods in three-phase voltage-source inverters," Machines, vol. 12, no. 9, pp. 1–20, 2024.
- [8] K. Kiruthika, R. Devi, and S. Kumar, "Fault detection in IEEE 9 bus system using MATLAB/Simulink," International Journal of Engineering Research and Technology (IJERT), vol. 14, no. 1, pp. 1–6, 2025.
- [9] A. Khan, S. Ahmad, and M. Tariq, "Fault detection and classification using wavelet transform in power systems," IEEE Access, vol. 8, pp. 56789–56798, 2020.
- [10] M. Patel and R. Mehta, "Simulation and analysis of transmission line faults using MATLAB/Simulink," International Journal of Engineering Research, vol. 10, no. 4, pp. 210–215, 2021.



INTERNATIONAL
STANDARD
SERIAL
NUMBER
INDIA



INTERNATIONAL JOURNAL OF INNOVATIVE RESEARCH

IN SCIENCE | ENGINEERING | TECHNOLOGY

 9940 572 462  6381 907 438  ijirset@gmail.com



www.ijirset.com

Scan to save the contact details